

## **ENGRAVING & LABEL MAKING**

---

**Let us make your engraved labels, nameplates, legend-plates, or tags. We can supply them with or without adhesive or add mounting holes.**

**Attached please find:**

- 1) Our price list**
- 2) General Engraving Notes**
- 3) Order Form**
- 4) Samples of Legend Plates & Pendant Plates**

**Feel free to:**

- A) Fax or call 206-279-1897 or**
- B) E-mail me at: [dick@dickscustomengraving.com](mailto:dick@dickscustomengraving.com)**

**We've got a wide variety of colors & materials available and can give you rapid turnaround on most orders.**

Email: [dick@dickscustomengraving.com](mailto:dick@dickscustomengraving.com)

---

## Engraving General Notes:

- 1) We can offer 60 different fonts on labels. Our standard is Gothic Oneline. We have international fonts available (such as Arabic, Arabic/Farsi, German, Old Style, Greek, Cyrillic Gothic [Russian], Hebrew, & Hebrew S'Tam.
- 2) Standard Text Size is 3/16" (at 80%).
- 3) Standard material stocked is Ultra-Matte Finish (which is UV Protected). More available.
- 4) Colors are:
  - 4.1) White Surface/Black Core (letters)
  - 4.2) Black Surface/White Core (letters)
  - 4.3) White Surface/Red Core (letters)
  - 4.3.1) Red Surface/White Core (letters)
  - 4.4) Yellow Surface/Black Core (letters)
  - 4.X) Lots of custom order colors available, special order only
- 5) We offer QUICK turnaround service.
- 6) We can engrave your logo in the label material if you send us an AutoCad or DXF file. Email it to [dick@dickscustomengraving.com](mailto:dick@dickscustomengraving.com)
- 7) All labels have 1/32" Double Backed Adhesive Foam Tape. (White or Black available)
- 8) Mounting Holes are also available in rectangular labels.
- 9) Label Numbers are based upon rough size in 1/4" increments, such as Label 3.6 is a 3/4" (3 x 1/4") by 1-1/2" (6 x 1/4") sized label.
- 10) Labels shown in this document reflect a beveled edge.

**ENGRAVING/LABEL PRICING**

**PHONE: 206-279-1897**

**FAX: 206-279-1897**

| Label Number         | Label Size        | Unit          | Letters/Line w/o Holes | Letters/Line with Holes | Foam Tape |
|----------------------|-------------------|---------------|------------------------|-------------------------|-----------|
| 2.04                 | 1/2" x 1"         | \$2.00        | 4                      | 2                       | \$0.10    |
| 2.06                 | 1/2" x 1-1/2"     | \$2.00        | 7                      | 5                       | \$0.10    |
| 2.08                 | 1/2" x 2"         | \$2.00        | 10                     | 8                       | \$0.10    |
| 2.10                 | 1/2" x 2-1/2"     | \$2.00        | 13                     | 11                      | \$0.10    |
| 2.12                 | 1/2" x 3"         | \$2.00        | 16                     | 14                      | \$0.10    |
| 2.14                 | 1/2" x 3-1/2"     | \$2.00        | 19                     | 17                      | \$0.10    |
| 2.16                 | 1/2" x 4"         | \$2.00        | 22                     | 20                      | \$0.10    |
| 2.20                 | 1/2" x 5"         | \$2.38        | 28                     | 26                      | \$0.13    |
|                      |                   |               |                        |                         |           |
| 3.06                 | 3/4" x 1-1/2"     | \$2.00        | 7                      | 5                       | \$0.10    |
| 3.08                 | 3/4" x 2"         | \$2.00        | 10                     | 8                       | \$0.10    |
| 3.10                 | 3/4" x 2-1/2"     | \$2.00        | 13                     | 11                      | \$0.10    |
| 3.12                 | 3/4" x 3"         | \$2.14        | 16                     | 14                      | \$0.11    |
| 3.14                 | 3/4" x 3-1/2"     | \$2.49        | 19                     | 17                      | \$0.13    |
| 3.16                 | 3/4" x 4"         | \$2.85        | 22                     | 20                      | \$0.15    |
| 3.18                 | 3/4" x 5"         | \$3.56        | 28                     | 26                      | \$0.19    |
|                      |                   |               |                        |                         |           |
| 4.08                 | 1" x 2"           | \$2.00        | 10                     | 8                       | \$0.10    |
| 4.10                 | 1" x 2-1/2"       | \$2.38        | 13                     | 11                      | \$0.13    |
| 4.12                 | 1" x 3"           | \$2.85        | 16                     | 14                      | \$0.15    |
| 4.14                 | 1" x 3-1/2"       | \$3.33        | 19                     | 17                      | \$0.18    |
| 4.16                 | 1" x 4"           | \$3.80        | 22                     | 20                      | \$0.20    |
| 4.20                 | 1" x 5"           | \$4.75        | 28                     | 26                      | \$0.25    |
| 4.24                 | 1" x 6"           | \$5.70        | 34                     | 32                      | \$0.30    |
| 8.12                 | 2" x 3"           | \$5.70        | 16                     | 14                      | \$0.30    |
| 8.16                 | 2" x 4"           | \$7.60        | 22                     | 20                      | \$0.40    |
| 8.20                 | 2" x 5"           | \$9.50        | 28                     | 26                      | \$0.50    |
| 8.24                 | 2" x 6"           | \$11.40       | 34                     | 32                      | \$0.60    |
| 12.48                | 3" X 12"          | \$34.20       | 12                     | 10                      | \$1.80    |
| <b>DRILL HOLES</b>   | <b>0.125" DIA</b> | <b>\$0.25</b> | <b>PER HOLE</b>        |                         |           |
| 30mmLegend           |                   | \$2.75        |                        |                         |           |
| 30mmJumboP           |                   | \$3.50        |                        |                         |           |
| 22mmLegend           |                   | \$2.75        |                        |                         |           |
| <b>30mm ESTOP</b>    | YELLOW            | \$4.00        |                        |                         |           |
| 30mmAlum             |                   | \$3.50        |                        |                         |           |
| 30mmJumboA           |                   | \$4.00        |                        |                         |           |
| Custom 22mm or 30 mm |                   | \$3.50        |                        |                         |           |
| Pendant              |                   | \$4.00        |                        |                         |           |

**NOTES:**

1. IN ORDER TO GET OUR CUSTOMERS GREAT PRICING ON LABELS, WE ASK FOR A \$10.00 MINIMUM ON EACH ORDER
2. SCREWS FOR LABELS WITH HOLES SHOULD BE ROUND HEAD TYPE (<0.313 DIA.)
3. TO ESTIMATE A LABEL COST USE THE (a) UNIT PRICE, (b) ADDER FOR HOLES, AND/OR (c) ADDER FOR FOAM TAPE
4. ALL LABEL PRICING BASED UPON PLASTIC MATERIALS (WE CAN DO BRASS OR STAINLESS, BUT CALL FOR PRICING)
5. PRICING SUBJECT TO CHANGE WITHOUT NOTICE

FAX TO: DICK'S CUSTOM ENGRAVING  
Email: [dick@dickscustomengraving.com](mailto:dick@dickscustomengraving.com)

FAX: 206-279-1897  
Phone: 206-279-1897

Order FROM: \_\_\_\_\_  
Contact Person: \_\_\_\_\_  
Phone/Fax: \_\_\_\_\_ / \_\_\_\_\_  
Ship to: \_\_\_\_\_  
\_\_\_\_\_  
\_\_\_\_\_  
\_\_\_\_\_

P.O. # \_\_\_\_\_  
  
Bill to: \_\_\_\_\_  
\_\_\_\_\_  
\_\_\_\_\_  
\_\_\_\_\_

| Item | Qty | Label # | Line1 | Line2 | Line3 | Line4 |
|------|-----|---------|-------|-------|-------|-------|
| 1    |     |         |       |       |       |       |
| 2    |     |         |       |       |       |       |
| 3    |     |         |       |       |       |       |
| 4    |     |         |       |       |       |       |
| 5    |     |         |       |       |       |       |
| 6    |     |         |       |       |       |       |
| 7    |     |         |       |       |       |       |
| 8    |     |         |       |       |       |       |
| 9    |     |         |       |       |       |       |
| 10   |     |         |       |       |       |       |
| 11   |     |         |       |       |       |       |
| 12   |     |         |       |       |       |       |
| 13   |     |         |       |       |       |       |
| 14   |     |         |       |       |       |       |
| 15   |     |         |       |       |       |       |
| 16   |     |         |       |       |       |       |
| 17   |     |         |       |       |       |       |
| 18   |     |         |       |       |       |       |
| 19   |     |         |       |       |       |       |
| 20   |     |         |       |       |       |       |
| 21   |     |         |       |       |       |       |
| 22   |     |         |       |       |       |       |
| 23   |     |         |       |       |       |       |
| 24   |     |         |       |       |       |       |
| 25   |     |         |       |       |       |       |
| 26   |     |         |       |       |       |       |
| 27   |     |         |       |       |       |       |
| 28   |     |         |       |       |       |       |
| 29   |     |         |       |       |       |       |
| 30   |     |         |       |       |       |       |

DOWNLOAD THIS FORMAT: [http://www.dickscustomengraving.com/engrave\\_order.xls](http://www.dickscustomengraving.com/engrave_order.xls)

[www.DicksCustomEngraving.com](http://www.DicksCustomEngraving.com)

JOB NO. \_\_\_\_\_ CUSTOMER \_\_\_\_\_ DATE: \_\_\_\_\_

| LINE 1 | LINE 2 | LINE 3 | LINE 4 | LINE 5 |
|--------|--------|--------|--------|--------|
|        |        |        |        |        |
|        |        |        |        |        |
|        |        |        |        |        |
|        |        |        |        |        |
|        |        |        |        |        |
|        |        |        |        |        |
|        |        |        |        |        |
|        |        |        |        |        |
|        |        |        |        |        |

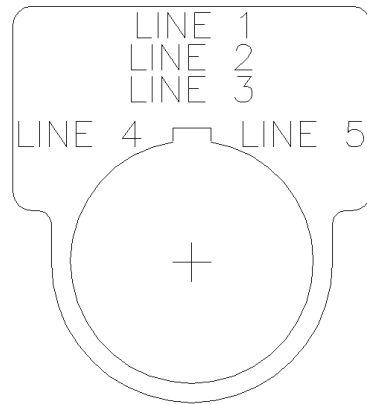
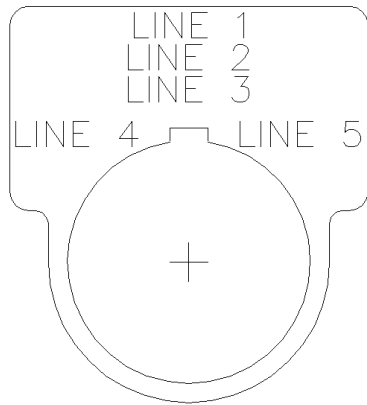
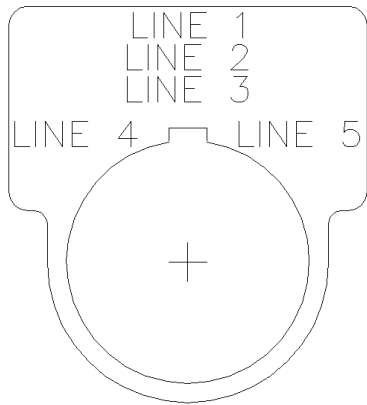
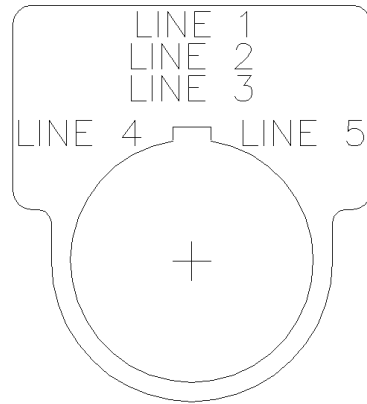
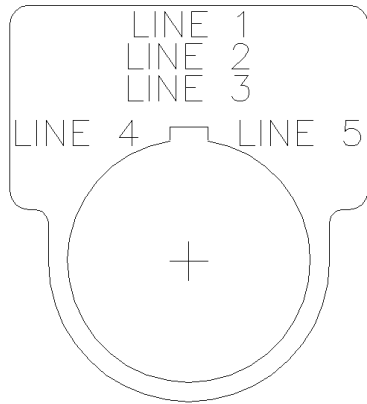
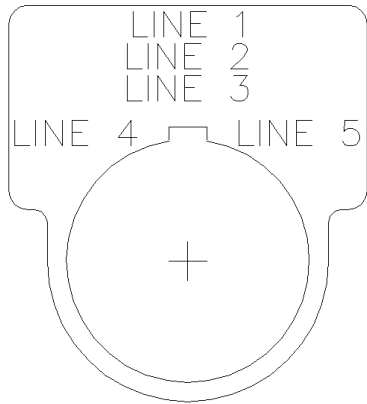
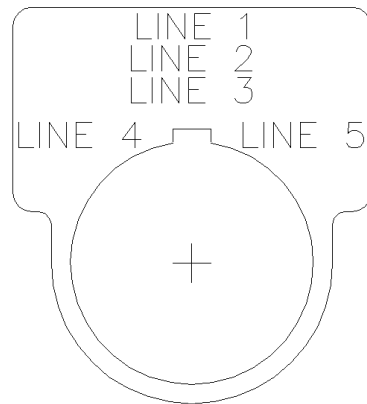
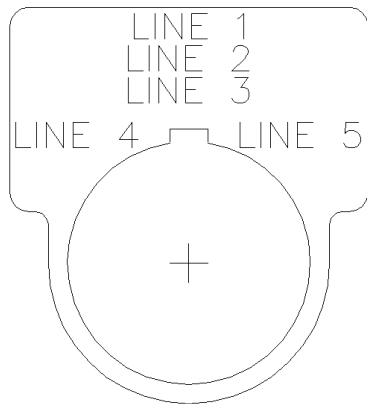
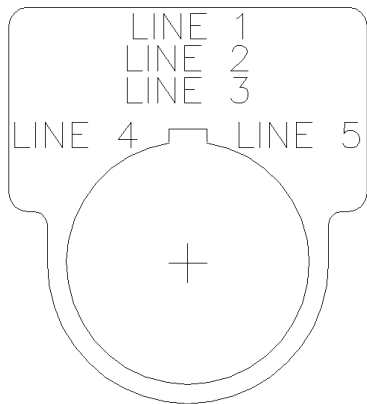

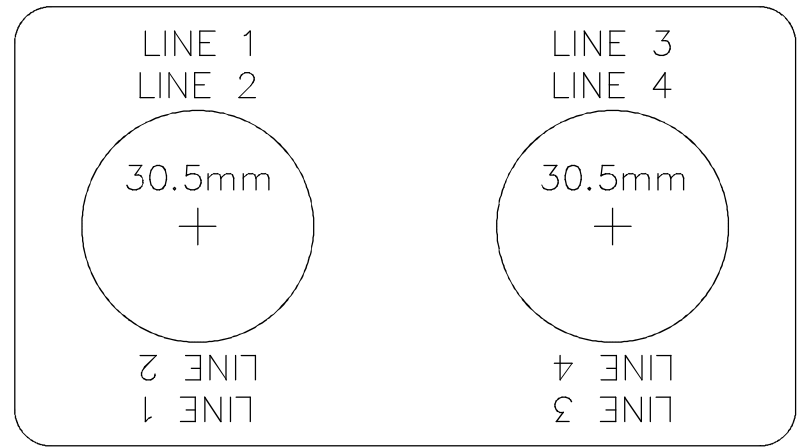
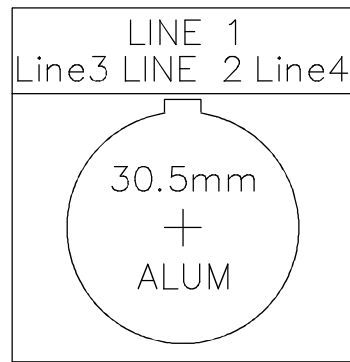
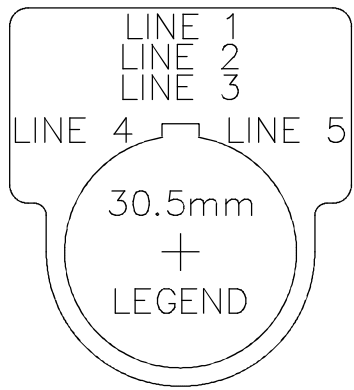

Square-D Pendant Label

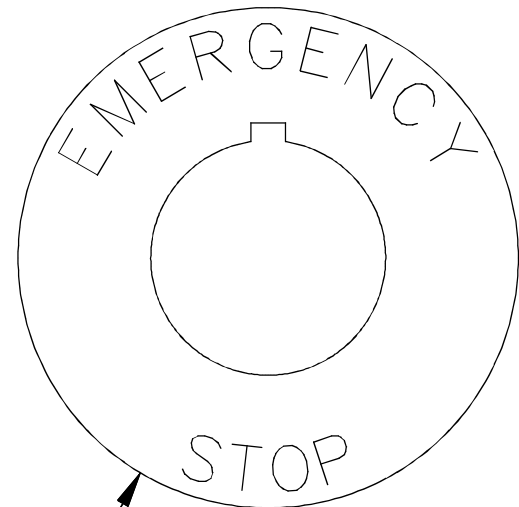
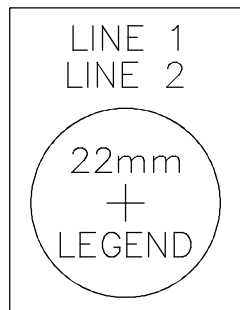
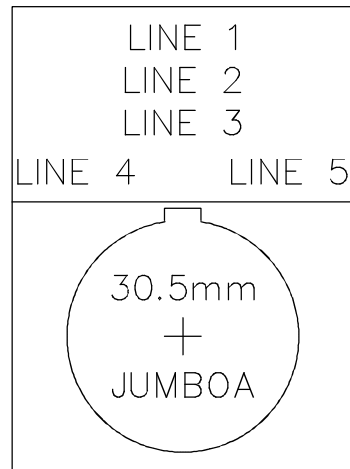
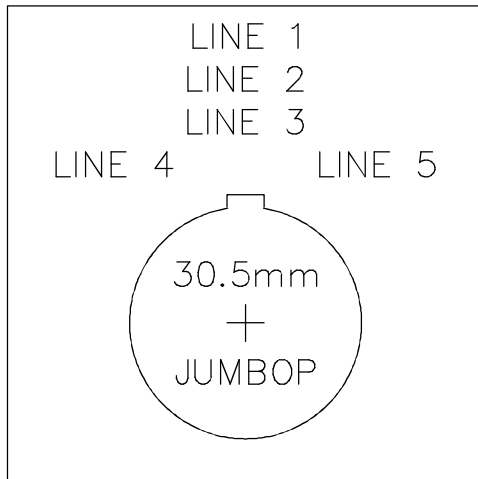

YELBACKGROUND/BLK TEXT  
(IAW NFPA 79)

# DCE Engraving 1/2" Labels

LABEL 2.4 (1/2" X 1")

LINE 1  
LINE 2

LABEL 2.6 (1/2" X 1-1/2")

LINE 1  
LINE 2

LABEL 2.8 (1/2" X 2")

LINE 1  
LINE 2

LABEL 2.10 (1/2" X 2-1/2")

LINE 1  
LINE 2

LABEL 2.12 (1/2" X 3")

LINE 1  
LINE 2

LABEL 2.14 (1/2" X 3-1/2")

LINE 1  
LINE 2

LABEL 2.16 (1/2" X 4")

LINE 1  
LINE 2

LABEL 2.20 (1/2" X 5")

LINE 1  
LINE 2

# DCE Engraving 3/4" Labels

LABEL 3.6 (3/4" X 1-1/2")



LABEL 3.8 (3/4" X 2")



LABEL 3.10 (3/4" X 2-1/2")



LABEL 3.12 (3/4" X 3")



LABEL 3.14 (3/4" X 3-1/2")



LABEL 3.16 (3/4" X 4")

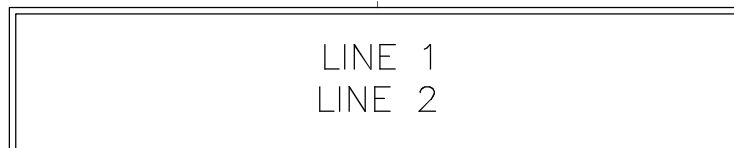

LABEL 3.18 (3/4" X 4-1/2")

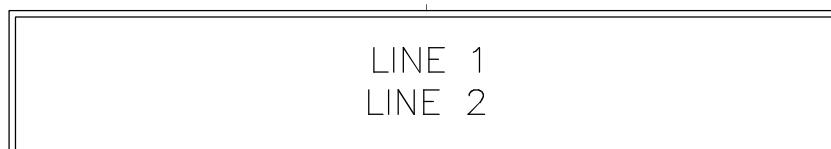



# DCE Engraving 1" Labels

LABEL 4.8 (1" X 2")

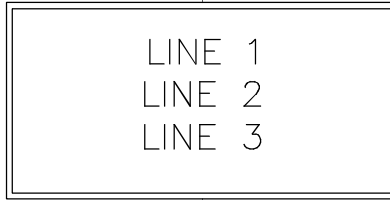

LABEL 4.10 (1" X 2-1/2")

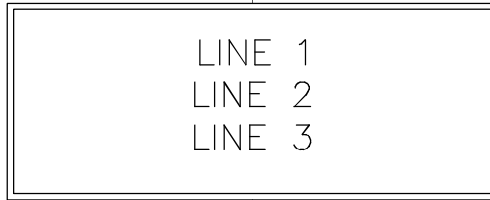

LABEL 4.12 (1" X 3")

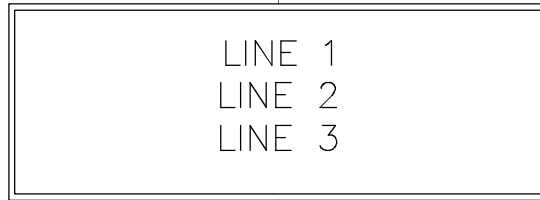

LABEL 4.14 (1" X 3-1/2")

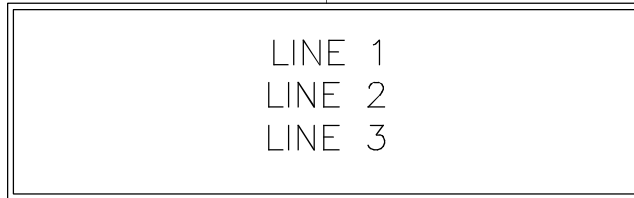

LABEL 4.16 (1" X 4")

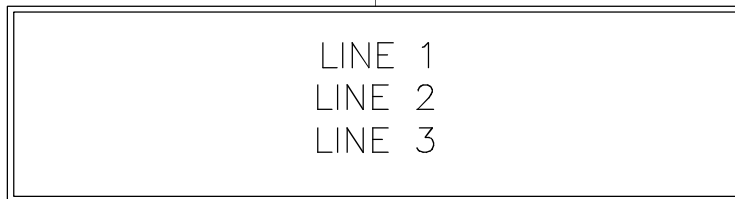

LABEL 4.20 (1" X 5")

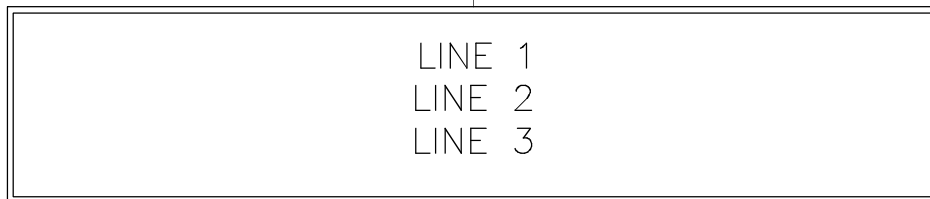

# DCE Engraving 2" Labels

LABEL 8.12 (2" X 3")

|        |
|--------|
| LINE 1 |
| LINE 2 |
| LINE 3 |
| LINE 4 |

LABEL 8.12 (2" X 4")

|        |
|--------|
| LINE 1 |
| LINE 2 |
| LINE 3 |
| LINE 4 |

LABEL 8.20 (2" X 5")

|        |
|--------|
| LINE 1 |
| LINE 2 |
| LINE 3 |
| LINE 4 |

LABEL 8.24 (2" X 6")

|        |
|--------|
| LINE 1 |
| LINE 2 |
| LINE 3 |
| LINE 4 |